

Description

Piezo-operated proportional pressure regulator based on the principle of a piezo element which bends when voltage is applied. At the end of the piezo element is a flapper valve, which operates against a precision nozzle to create back pressure on the control diaphragm of a booster relay. A pressure transducer provides feedback of the outlet pressure compared with the setpoint value with correction by the electronic control system if necessary.

Minimal power consumption

- no self-heating, even none at pressure absence
- safe battery operation over a long period

Piezo element

- almost no power consumption necessary for regulation
- extremely quick regulating operations
- low-noise regulation especially for medical and laboratory technology

Small and light design

- particularly suitable for portable devices in conjunction with battery operation
- ideal for limited space conditions

PRE1

DN 2.5, 350 l/min, coupling socket M8x1, 3-pin,
monitor signal optionally 0... P_{2max} \triangleq 0...10 V,

monitor signal, 4-pin
max. 1 mA, $R_a > 1k\Omega$

PRE2

DN 6, 1600 l/min, coupling socket M12x1.5, 5-pin
monitor signal standard 0... P_{2max} \triangleq 0...10 V,

max. 1 mA, $R_a > 1k\Omega$

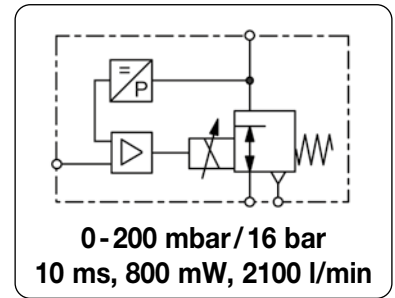

General features

Description	Piezo-operated 3-port/2-way proportional pressure regulator with internal pressure sensor and closed loop.		
Protection class	IP 30 for PRE1 according to DIN EN 60529 IP 65 for PRE2 according to DIN EN 60529 with coupling socket and tapped exhaust		
Mounting position	any		
Temperature range	0 °C to 50 °C / 32 °F to 122 °F		
Material	Body: plastic, PRE1 IXEF1022	PRE2 Grivity G VX-65H	Elastomer: NBR/Buna-N Inner valve: brass and spring steel

Pneumatic features

Media	dry, unlubricated and 5 μ m filtered compressed air or non-corrosive gases		
Supply pressure	min. 1.5 bar (at $P_2 \leq 8$ bar) or 2 bar (at $P_2 \geq 8$ bar) and additional P_1 : min. 1 bar greater than P_2 max. 2.5 bar up to 17 bar, depending on pressure range according to chart		
Flow rate	PRE1: max. 350 l/min at $P_1 = 10$ bar, $P_2 = 6$ bar and open outlet	DN 2.5	
	PRE2: max. 1600 l/min at $P_1 = 10$ bar, $P_2 = 6$ bar and open outlet	DN 6	
Exhaust	PRE1: 180 l/min at $P_2 = 6$ bar, 20 l/min at $P_2 = 200$ mbar		
	PRE2: 1000 l/min at $P_2 = 6$ bar, 400 l/min at $P_2 = 2$ bar		
Air consumption	PRE1: < 1.0 l/min independent of pressure range PRE2: < 1.0 l/min independent of pressure range		

Electrical features

Supply voltage	PRE1: 24 V DC \pm 10%, 0.4 W, current consumption max. 15 mA PRE2: 24 V DC \pm 10%, 0.8 W, current consumption max. 30 mA		
Command signal	4...20 mA or 0...10 V		
Impedance	PRE1: $\geq 66 k\Omega$ at voltage signal, $\leq 500 \Omega$ at current signal		
	PRE2: $\geq 55 k\Omega$ at voltage signal, $\leq 500 \Omega$ at current signal		
Electrical connector	PRE1: coupling socket M8x1, 3-pin	PRE1-R: coupling socket M8x1, 4-pin	
	PRE2: coupling socket M12x1.5, 5-pin		
Monitor signal	PRE1-U.R: as option	0... P_{2max} / 0...10 V, max. 1 mA, $R_a > 1k\Omega$	
	PRE2: standard	0... P_{2max} / 0...10 V, max. 1 mA	
Electronic switch	PRE2 only, PNP, "on" when setpoint and actual value match in the tolerance range 0 V DC = off, $U_N = -0.7$ V DC = on, output current < 200 mA, tolerance $P_2: \pm 2\%$		
Failsafe	If signal or electrical supply fails, outlet pressure falls to zero and the regulator exhausts.		
Note	For long connection lines shielding is to be used. Pay attention to voltage drops. As the case may be, current signal is preferable.		

Accuracy

Linearity	< 0.5% FS,	at 0.2 bar range	< 1 % FS
Hysteresis	< 0.2% FS,	at 0.2 bar range	< 0.5% FS
Response sensitivity	< 0.1% FS,	at 0.2 bar range	< 0.5% FS at PRE1 < 0.2% FS at PRE2
Repeatability	< 0.2% FS,	at 0.2 bar range	< 0.5% FS
Response time	10 ms		
Over all accuracy	$\pm 0.2\%$ FS (Monitor signal $\pm 1.5\%$ FS)		

Adjustment

Zero point	calibration only by factory
Range	calibration only by factory

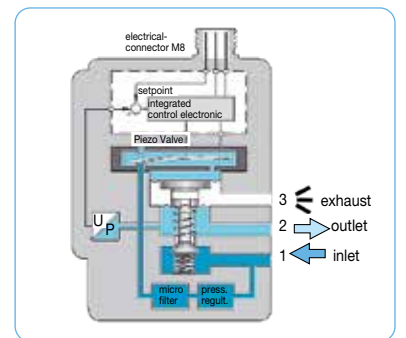
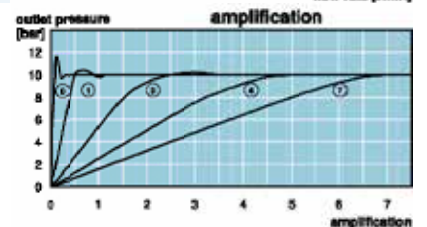
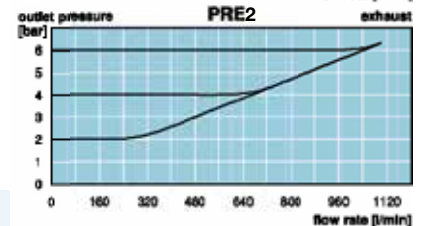
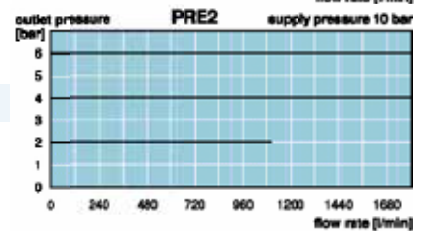
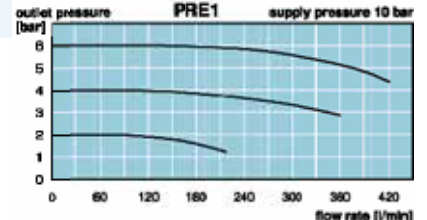

cross-section PRE1

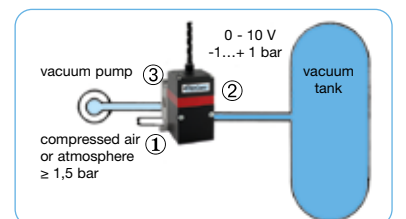

PRE2-V1 for vacuum

Technical features

- Highly dynamic** 10 ms, critical frequency 43 Hz
- Low power consumption** 400 mW / 800 mW nominal power
- No self-heating** due to low power consumption
- Battery operation** due to low power consumption
- For portable devices** up to 3 bar pressure range
- No over-oscillation** adjustable closed loop amplification
- No resonance oscillation** adjustable closed loop amplification
- Linearity** < 0.5% or 1% FS
- Hysteresis** < 0.2% or 0.5% FS
- Response sensitivity** < 0.1% or 0.5% FS
- Repeatability** < 0.2% or 0.5% FS
- Failsafe** exhaust at power breakdown
- Protection class** IP 30 or IP 65
- Two-wire system** for signal 4...20 mA

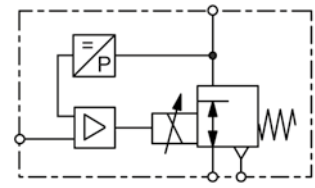

0 ... 200 mbar / 16 bar
10 ms, 800 mW, 2400 l/min

Dimensions			Supply pressure	Flow rate	Connection thread	Pressure range	Order number for inlet signal	
A	B	C	max. bar	l/min*1	G	bar	4-20 mA	0-10 V

Proportional press. regl.						supply voltage 24 V DC, constant bleed, with straight coupling socket and 5 m cable	PRE	PRE
36	61	53	2.5	100	G $\frac{1}{8}$	0...0.2	PRE1-IA2	PRE1-UA2
			6.0	200		0... 2	PRE1-I02	PRE1-U02
			10	250		0... 5	PRE1-I05	PRE1-U05
				280		0... 6	PRE1-I06	PRE1-U06
				350		0... 8	PRE1-I08	PRE1-U08
46	84	68	2.5	800	G $\frac{1}{4}$	-1... 1	PRE2-IV1	PRE2-UV1
			10	1500		-1... 4	PRE2-I04V1	PRE2-U04V1
				1500		-1... 6	PRE2-I06V1	PRE2-U06V1
			12	1700		-1... 10	PRE2-I10V1	PRE2-U10V1
			2.5	500		0... 0.5	PRE2-IA5	PRE2-UA5
				900		0... 1	PRE2-I01	PRE2-U01
			7.0	1100		0... 2	PRE2-I02	PRE2-U02
				1100		0... 3	PRE2-I03	PRE2-U03
			10	1500		0... 4	PRE2-I04	PRE2-U04
				1500		0... 5	PRE2-I05	PRE2-U05
				1500		0... 6	PRE2-I06	PRE2-U06
			12	1700		0... 10	PRE2-I10	PRE2-U10
17	2400		0... 16	PRE2-I16	PRE2-U16			



PRE1



PRE2

Special options, add the appropriate letter

- monitor signal** 0-10 V, standard at PRE2 for PRE1-U PRE1-...R
- flange connection** without manifold PRE-...F
- w/o coupling socket** and without cable PRE-...H
- mounting clips** for DIN rail PRE-...C
- deviant pressure ranges** PRE-...XX

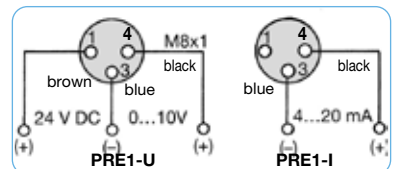

connection diagram

Accessories, enclosed

- coupling socket** with 5 m cable, angular
 - M8x1, 3-pin for PRE1 **KM08-C3-5**
 - M8x1, 4-pin for PRE1-R **KM08-C4-5**
 - M12x1.5, 5-pin for PRE2 **KM12-C5-5**

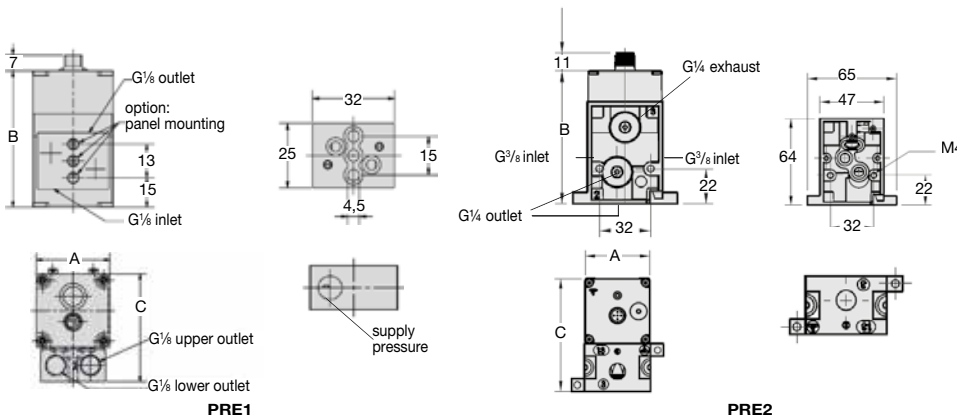

*1 at open outlet

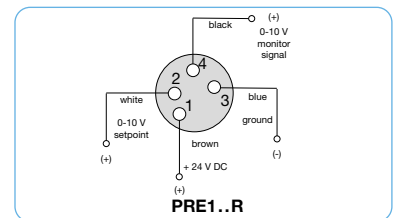

connection diagram

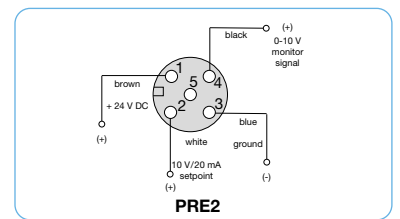

connection diagram

* Product group

Technical details: see previous page

PDF CAD
www.aircom.net



Order example:
PRE1-IA1